



SWIMMING POOL
PRICE LIST 02-2025

TIPO TYPE	CV HP	PVP € Bomba/Pump Optima
--------------	----------	-------------------------------



OPTIMA- AUTOASPIRANTES PARA PISCINAS

OPTIMA 25 M	0,25	373,00
OPTIMA 25 T	0,25	378,00
OPTIMA 33 M	0,33	373,00
OPTIMA 33 T	0,33	378,00
OPTIMA 50 M	0,5	396,00
OPTIMA 50 T	0,5	401,00
OPTIMA 75 M	0,75	406,00
OPTIMA 75 T	0,75	431,00
OPTIMA 100 M	1	449,00
OPTIMA 100 T	1	456,00
OPTIMA 150 M	1,5	516,00
OPTIMA 150 T	1,5	523,00

TIPO TYPE	CV HP	PVP € Bomba/Pump Winner	PVP € con variador with inverter Vario Winner
--------------	----------	-------------------------------	--

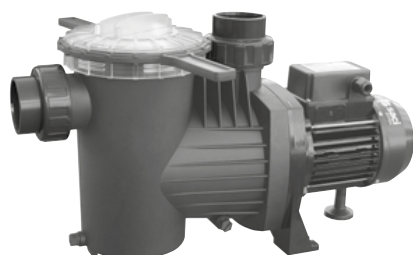

WINNER- AUTOASPIRANTES PARA PISCINAS

WINNER 33 M	0,33	439,00	1.387,00
WINNER 33 T	0,33	467,00	-
WINNER 50 M	0,5	439,00	1.387,00
WINNER 50 T	0,5	467,00	-
WINNER 75 M	0,75	470,00	1.421,00
WINNER 75 T	0,75	501,00	-
WINNER 100 M	1	521,00	1.440,00
WINNER 100 T	1	532,00	-
WINNER 150 M	1,5	566,00	1.494,00
WINNER 150 T	1,5	576,00	-
WINNER 200 M	2	663,00	1.580,00
WINNER 200 T	2	663,00	-
WINNER 300 M	3	780,00	1.630,00
WINNER 300 T	3	714,00	-

KIT SOPORTE PARED [e]JOY

95,00



[e]WINNER- VELOCIDAD VARIABLE CON MOTOR DE IMANES PERMANENTES

[e]WINNER 150 M	MAX 1,5 HP	1.350,00
[e]WINNER 300 M	MAX 3 HP	1.729,00
[e]WINNER PRO	MAX 3 HP	1.754,00
SOPORTE PARED VARIADOR		95,00

TIPO TYPE	CV HP	PVP €
--------------	----------	-------



CUADRO ELÉCTRICO PARA BOMBAS DE PISCINA

SMART POOL COMPLETO (PARED / WALL)		277,00
SMART POOL PRO (PARED / WALL)		401,00
CUADRO (PANEL) FOCOS LED 50W		151,00
CUADRO (PANEL) FOCOS LED 2x50W		191,00
SONDA (PROBE) TEMPERATURA PT-100 1/4" AISI 316		77,00

	TIPO TYPE	CV HP	PVP € Bomba/Pump	PVP € con variador/with inverter Vario Supra
	SUPRA- AUTOASPIRANTES PARA PISCINAS			
	SUPRA 300 M	3	1.255,00	-
	SUPRA 300	3	1.142,00	2.242,00
	SUPRA 400	4	1.221,00	2.322,00
	SUPRA 550	5,5	1.459,00	2.560,00

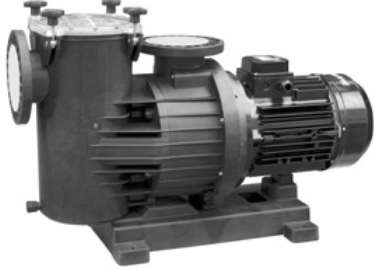
	TIPO TYPE	CV HP	PVP € Bomba/Pump Magnus	PVP € con variador with inverter Vario Magnus
	MAGNUS- AUTOASPIRANTES PARA PISCINAS			
	MAGNUS-4 250	2,5	1.499,00	2.617,00
	MAGNUS-4 300	3	1.499,00	2.617,00
	MAGNUS-4 400	4	1.536,00	2.654,00
	MAGNUS-4 550	5,5	1.728,00	2.846,00
	MAGNUS-4 550 (R. Bronce)	5,5	2.284,00	3.402,00
	MAGNUS-4 750	7,5	2.321,00	4.536,00
	MAGNUS-4 750 (R. Bronce)	7,5	2.769,00	4.984,00
	MAGNUS-4 1000	10	2.490,00	4.706,00
	MAGNUS-4 1000 (R. Bronce)	10	2.926,00	5.141,00
	MAGNUS-2 1250	12,5	2.972,00	5.187,00
MAGNUS-2 1500	15	3.018,00	5.233,00	

BOMBAS A 1.450RPM EXCEPTO
MODELOS DE 12,5CV Y 15CV
PUMPS AT 1,450RPM EXCEPT
THE 12,5HP AND 15HP TYPES

KIT CONTRABRIDAS PVC DN-110



143,00

* Las bombas VARIO MAGNUS incorporan el variador [e]POOL TT3



* The VARIO MAGNUS pumps includes the [e]POOL TT3 inverter

	TIPO TYPE	CV HP	PVP € Bomba Pump
	[e]MAGNUS BOMBA PISCINA VELOCIDAD VARIABLE CON MOTOR DE IMANES PERMANENTES		
	[e]MAGNUS-4 550	5,5	3.779,00
	[e]MAGNUS-4 550 (ROD. BRONCE)	5,5	4.322,00
	SOPORTE PARED VARIADOR		95,00

	TIPO TYPE	CV HP	PVP € con variador with inverter Vario Magnus
	VERT MAGNUS- AUTOASPIRANTES PARA PISCINAS		
	VERT MAGNUS-4 250	2,5	5.179,00
	VERT MAGNUS-4 300	3	5.179,00
	VERT MAGNUS-4 400	4	5.229,00
	VERT MAGNUS-4 550	5,5	5.430,00
	VERT MAGNUS-4 550 (R. Bronce)	5,5	5.911,00
	VERT MAGNUS-4 750	7,5	5.666,00
	VERT MAGNUS-4 750 (R. Bronce)	7,5	6.151,00
	VERT MAGNUS-4 1000	10	5.895,00
	VERT MAGNUS-4 1000 (R. Bronce)	10	6.389,00
	VERT MAGNUS-2 1250	12,5	6.492,00
VERT MAGNUS-2 1500	15	6.549,00	





TIPO TYPE	CV HP	PVP € CF-2	PVP € VERT CF-2 (Vertical)
CF-2- 2,900 RPM			
CF-2 300 (2.900 r.p.m.)	3	2.413,00	3.892,00
CF-2 400 (2.900 r.p.m.)	4	2.628,00	4.007,00
CF-2 550 (2.900 r.p.m.)	5,5	3.134,00	4.448,00
CF-2 551 (2.900 r.p.m.)	5,5	3.141,00	4.460,00
CF-2 750 (2.900 r.p.m.)	7,5	3.527,00	4.878,00
CF-2 1000 (2.900 r.p.m.)	10	3.759,00	5.297,00
CF-2 1250 (2.900 r.p.m.)	12,5	4.231,00	5.636,00
CF-2 1500 (2.900 r.p.m.)	15	4.443,00	5.857,00



TIPO TYPE	CV HP	PVP € HF-2	PVP € VERT HF-2 (Vertical)
HF-2- GRAN ALTURA A 2,900 RPM			
HF-2 308 (2.900 r.p.m.)	3	3.033,00	4.508,00
HF-2 408 (2.900 r.p.m.)	4	3.226,00	4.702,00
HF-2 558 (2.900 r.p.m.)	5,5	3.358,00	4.803,00
HF-2 758 (2.900 r.p.m.)	7,5	4.089,00	5.471,00
HF-2 1008 (2.900 r.p.m.)	10	4.508,00	5.802,00
HF-2 1208 (2.900 r.p.m.)	10	4.469,00	5.786,00
HF-2 1508 (2.900 r.p.m.)	15	5.352,00	6.585,00
HF-2 2008 (2.900 r.p.m.)	20	5.679,00	6.920,00
HF-2 2508 (2.900 r.p.m.)	25	5.986,00	7.122,00

NO EQUIPAN CONTRABRIDAS / COUNTERFLANGES NOT INCLUDED

TIPO TYPE	CV HP	PVP € CF-4	PVP € VERT CF-4 (Vertical)
CF-4- 1,450 RPM			
CF-4 300 (1.450 r.p.m.)	3	3.342,00	4.924,00
CF-4 400 (1.450 r.p.m.)	4	3.731,00	5.325,00
CF-4 550 (1.450 r.p.m.)	5,5	3.907,00	5.510,00
CF-4 552 (1.450 r.p.m.)	5,5	4.330,00	5.923,00
CF-4 750 (1.450 r.p.m.)	7,5	4.646,00	6.253,00
CF-4 1000 (1.450 r.p.m.)	10	5.368,00	7.002,00
CF-4 1500 (1.450 r.p.m.)	15	6.897,00	8.268,00
CF-4 2000 (1.450 r.p.m.)	20	7.983,00	8.844,00
CF-4 2500 (1.450 r.p.m.)	25	8.711,00	9.449,00

NO EQUIPAN CONTRABRIDAS / COUNTERFLANGES NOT INCLUDED

TIPO TYPE	CV HP	PVP € HF-4	PVP € VERT HF-4 (Vertical)
HF-4- GRAN ALTURA A 1,450 RPM			
HF-4 308 (1.450 r.p.m.)	3	3.868,00	5.344,00
HF-4 408 (1.450 r.p.m.)	4	3.920,00	5.396,00
HF-4 558 (1.450 r.p.m.)	5,5	4.208,00	5.684,00
HF-4 758 (1.450 r.p.m.)	7,5	5.256,00	6.727,00
HF-4 1008 (1.450 r.p.m.)	10	6.132,00	7.604,00
HF-4 1508 (1.450 r.p.m.)	15	7.179,00	8.294,00
HF-4 2008 (1.450 r.p.m.)	20	7.602,00	8.839,00
HF-4 2508 (1.450 r.p.m.)	25	8.681,00	9.745,00
HF-4 3008 (1.450 r.p.m.)	30	9.064,00	9.929,00

NO EQUIPAN CONTRABRIDAS / COUNTERFLANGES NOT INCLUDED

	TIPO TYPE	PVP €
--	--------------	-------



VARIADORES DE FRECUENCIA PARA BOMBAS DE PISCINA

KIT VARIADOR [e]JOY (MM9) + SOPORTE PARED	650,00
VARIADOR DE VELOCIDAD [e]JOY (MT2)	798,00
VARIADOR DE VELOCIDAD [e]JOY (TT3-11)	1.015,00
VARIADOR DE VELOCIDAD [e]POOL (TT3-11)	997,00
VARIADOR DE VELOCIDAD [e]POOL (TT3-30)	1.975,00
SONDA TEMPERATURA NTC 47K B=4000 1/4" AISI 316	84,00
SOPORTE PARED VARIADOR [e]JOY - [e]POOL	95,00

TIPO TYPE	Conexiones Connections	PVP € Hierro/ Cast iron	PVP € Bronce/ Bronze
--------------	---------------------------	----------------------------	-------------------------



PREFILTROS COMPLETOS HIERRO Y BRONCE

F 65 / 65	DN-65	937,00	-
F 80 / 80	DN-80	937,00	CONSULTAR
F 100 / 100	DN-100	1.012,00	-
F 125 / 125	DN-125	1.012,00	CONSULTAR
F 150 / 150	DN-150	2.102,00	-
F 200 / 200	DN-200	2.131,00	-



V 65/65	DN-65	2.464,00	-
V 80/80	DN-80	2.464,00	-
V 100/100	DN-100	2.620,00	-
V 125/125	DN-125	2.620,00	-
V 150/150	DN-150	2.620,00	-

TIPO TYPE	Conexiones Connections	PVP €
--------------	---------------------------	-------



PREFILTROS SUELTOS ACERO INOX. AISI 316L

IH 65 / 65	DN-65	CONSULTAR
IH 80 / 80	DN-80	CONSULTAR
IH 100 / 100	DN-100	CONSULTAR
IH 125 / 125	DN-125	CONSULTAR
IH 150 / 150	DN-150	CONSULTAR
IH 200 / 200	DN-200	CONSULTAR

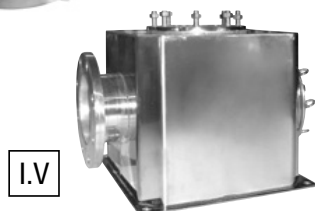

IV 100 / 65 VERT	DN 100-65	CONSULTAR
IV 100 / 80 VERT	DN 100-80	CONSULTAR
IV 125 / 100 VERT	DN 125-100	CONSULTAR
IV 150 / 125 VERT	DN 150-125	CONSULTAR
IV 200 / 150 VERT	DN 250-150	CONSULTAR

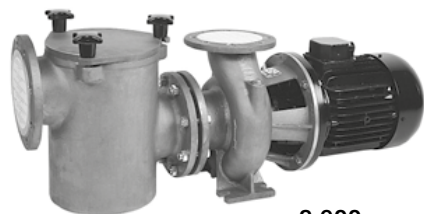

2.900 r.p.m.

BR-2- CENTRIFUGAS EN BRONCE MARINO

TIPO TYPE	CV HP	PVP € Motor IE-3
BR-2 300	3	CONSULTAR
BR-2 400	4	CONSULTAR
BR-2 550	5,5	CONSULTAR
BR-2 551	5,5	CONSULTAR
BR-2 750	7,5	CONSULTAR
BR-2 1000	10	CONSULTAR
BR-2 1250	12,5	CONSULTAR
BR-2 1500	15	CONSULTAR



POOLMATIC BOMBAS LIMPIAFONDOS AUTOMÁTICO

TIPO TYPE	CV HP	PVP € Monof/Single ph	PVP € Trif/Three ph
POOLMATIC 30 / 50	0,75	536,00	490,00
POOLMATIC 40 / 50	1	626,00	624,00

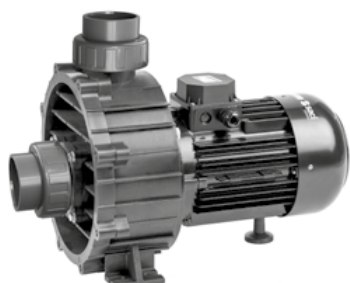

BRAVUS- CENTRIFUGAS CONTRA CORRIENTE

TIPO TYPE	CV HP	PVP € Bomba/Pump Bravus	PVP € con variador with inverter Vario Bravus
BRAVUS 300 M - 2900 RPM	3	1.148,00	-
BRAVUS 300 T - 2900 RPM	3	1.043,00	2.144,00
BRAVUS 400 T - 2900 RPM	4	1.130,00	2.230,00
BRAVUS 550 T - 2900 RPM	5,5	1.358,00	2.459,00



KONTRA- CENTRIFUGAS DE GRAN CAUDAL (CONTRACORRIENTE)

TIPO TYPE	CV HP	PVP € Bomba/Pump Kontra	PVP € con variador with inverter Vario Kontra
KONTRA-4 250	2,5	1.261,00	2.379,00
KONTRA-4 300	3	1.261,00	2.379,00
KONTRA-4 400	4	1.301,00	2.419,00
KONTRA-4 550	5,5	1.543,00	2.661,00
KONTRA-4 550 (ROD. BRONCE)	5,5	2.037,00	3.155,00
KONTRA-4 750	7,5	2.072,00	4.288,00
KONTRA-4 750 (ROD.BRONCE)	7,5	2.613,00	4.828,00
KONTRA-4 1000	10	2.222,00	4.437,00
KONTRA-4 1000 (ROD. BRONCE)	10	2.660,00	4.875,00
KONTRA-2 1250	12,5	2.706,00	4.921,00
KONTRA-2 1500	15	2.751,00	4.967,00
KIT CONTRABRIDAS PVC DN-110		143,00	

BOMBAS A 1.450RPM EXCEPTO MODELOS DE 12,5CV Y 15CV PUMPS AT 1,450RPM EXCEPT THE 12,5HP AND 15HP TYPES

* Las bombas VARIO KONTRA incorporan el variador [e]POOL TT3

* The VARIO KONTRA pumps includes the [e]POOL TT3 inverter



FILTROS LAMINADOS PISCINA PRIVADA

TIPO TYPE	Ø exterior	Caudal flow lts/h	Ø Ent. Ø Sal.	PVP € Valv. Lateral	PVP € Valv. TOP
SUN 400	400	6.500	1 1/2"	641,00	544,00
SUN 510	510	10.200	1 1/2"	709,00	622,00
SUN 620	620	15.100	1 1/2"	785,00	700,00
SUN 680	680	18.140	1 1/2"	1.104,00	942,00
SUN 750	750	22.000	2"	1.144,00	-
SUN 900	900	31.800	2"	1.468,00	-

Filtros de alto rendimiento. No incluyen arena.
High performance filters. Sand not included.



No incluyen batería de válvulas. Lecho filtrante de 1 metro. Incluye brazo colector. Bajo demanda 1,2 mts lecho y placa crepinas.
Battery valves not included. Filtration bed of 1 meter. Includes arm collector. Under demand 1,2 meters of filtration bed and/or Noozle plate.

FILTROS LAMINADOS PISCINA PÚBLICA

TIPO TYPE	20 m³/h/m² PVP €	30 m³/h/m² PVP €	40 m³/h/m² PVP €	50 m³/h/m² PVP €
SUN 1050	3.248,00	3.345,00	3.514,00	
SUN 1200	-	3.719,00	3.836,00	
SUN 1400	3.896,00	4.105,00	4.666,00	
SUN 1600	5.031,00	5.240,00	5.660,00	
SUN 1800	6.662,00	6.961,00	7.485,00	7.561,00
SUN 2000	8.687,00	8.973,00	9.650,00	9.842,00

SUPLEMENTO BOCA DE HOMBRE
SUPLEMENTO MIRILLA

1.593,00
638,00



FILTROS LAMINADOS ALTO RENDIMIENTO

High performance Laminated Filters

TIPO TYPE	20 m³/h/m² PVP €	30 m³/h/m² PVP €	40 m³/h/m² PVP €	50 m³/h/m² PVP €
FILTRO AR. LAM. SUN D.1050	4.462,00	4.796,00	5.035,00	
FILTRO AR. LAM. SUN D.1200	-	5.959,00	5.755,00	
FILTRO AR. LAM. SUN D.1400	6.104,00	6.705,00	7.163,00	
FILTRO AR. LAM. SUN D.1600	7.661,00	7.981,00	8.327,00	
FILTRO AR. LAM. SUN D.1800	9.397,00	9.820,00	10.559,00	10.717,00
FILTRO AR. LAM. SUN D.2000	11.019,00	11.388,00	12.245,00	12.489,00

BATERÍAS DE 5 VALVULAS



TIPO TYPE	PVP €
BATERÍA 5 VALVULAS DN 75	1.717,00
BATERÍA 5 VALVULAS DN 90	2.050,00
BATERÍA 5 VALVULAS DN 110	2.289,00
BATERÍA 5 VALVULAS DN 125	2.742,00
BATERÍA 5 VALVULAS DN 140	3.000,00
BATERÍA 5 VALVULAS DN 160	3.989,00
BATERÍA 5 VALVULAS DN 200	5.465,00

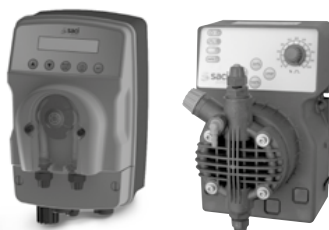

BOMBAS DOSIFICADORAS

PL 23	406,00
PL 50	662,00
PL 75	691,00
DOSING KIT PH 1,5 lts a 1,5 bar	867,00
DOSING KIT RX 1,5 lts a 1,5 bar	867,00

	TIPO TYPE	CV HP	PVP € Monof/Single ph	PVP € Trif/Three ph
--	--------------	----------	--------------------------	------------------------

BOMBAS SOPLANTES



BLOWER 80-400	0,6	642,00	642,00
BLOWER 140-850	1,2	804,00	804,00
BLOWER 140-131	1,8	858,00	858,00
BLOWER 210-131	1,8	943,00	943,00
BLOWER 210-151	2	1.041,00	-
BLOWER 210-161	2,2	-	1.000,00
BLOWER 315-221	3	-	1.458,00
BLOWER 315-301	4	-	1.628,00



	TIPO TYPE	PVP €
--	--------------	-------

A. CASCADA ALDARA MINI	1.510,00
B. CASCADA ALDARA	2.463,00
C. CASCADA RIMINI	2.208,00



A



B



C

CONDICIONES GENERALES DE VENTA

PEDIDOS

Los pedidos se cursarán preferentemente por correo electrónico, mencionando el número de pedido, la referencia del producto y la dirección de envío, y se registrarán por la tarifa de precios que esté en vigor.

Para los pedidos de material fabricados bajo expresa demanda (material no estándar) se requerirá de la oferta correspondiente sellada y firmada por el comprador.

BOMBAS SACI, S.A. se reserva el derecho de suministrar productos a aquellos clientes que en el momento de la entrega mantengan saldos impagados con nuestra firma. Mientras el cliente no haya satisfecho el valor total de la mercancía, BOMBAS SACI se reserva el dominio de la misma.

PLAZOS DE ENTREGA

Los plazos de entrega facilitados por nuestro departamento comercial son orientativos, y siempre entendiéndose la fecha informada como fecha de salida del material de nuestras instalaciones, por lo que no se atenderán reclamaciones por demoras en el tiempo de entrega.

PORTES DE ENVÍO

Los portes para envíos nacionales serán pagados cuando el importe neto de la factura sea superior a 600,00 €. Si el importe es menor, será enviado a portes debidos, o previo aviso se les cargará en factura una cantidad en concepto de portes. En caso de envío de material voluminoso (filtros y acumuladores entre otros) los costes de envío serán establecidos de antemano.

El receptor se verá obligado a revisar, en presencia del transportista, las condiciones del material recibido en sus instalaciones inmediatamente. En caso de encontrar material visiblemente dañado o faltante a la vista, se debe registrar convenientemente el hecho en el albarán del transportista y enviar notificación a BOMBAS SACI de la incidencia.

En caso de daños no visibles, se deberá enviar notificación por escrito al transportista y a BOMBAS SACI antes de las 24 horas siguientes a la fecha de recepción del material, o no se podrá efectuar reclamación alguna a posteriori.

DEVOLUCIONES

No se admitirán devoluciones de material transcurridos 15 días desde su recepción.

En caso de devolución dentro de este plazo, el material deberá sernos remitido perfectamente embalado y a portes pagados, o bien recogido por nuestra agencia de transporte previo acuerdo con nuestro departamento de incidencias. Se rechazará toda devolución a portes debidos.

Una vez recibido el material, se revisará su estado y se cargarán los conceptos necesarios para volver a dejar el material y su embalaje en perfecto estado.

Se deberán indicar en la documentación datos referentes a su expedición y facturación (nº de albarán, fecha de albarán, nº factura, etc...) y en ningún caso se aceptarán devoluciones que no hayan sido previamente acordadas.

Los productos de fabricación especial no están sujetos a devolución salvo defecto de fabricación, o salvo previo acuerdo con nuestro departamento de incidencias, y en este caso, se aplicará un demérito según causa.

GARANTÍAS

BOMBAS SACI, S.A. garantiza todos sus productos contra cualquier defecto de fabricación por un periodo de 3 años a partir de la fecha de factura del producto.

Sólo se aceptarán en garantía las piezas deterioradas y no el conjunto completo. La garantía queda limitada a la sustitución de las piezas defectuosas y mano de obra de sustitución de las mismas en nuestros talleres autorizados, y en ningún caso se aceptarán cargos en concepto de mano de obra, indemnizaciones, desplazamientos o mano de obra de montaje y desmontaje de las bombas en las instalaciones del cliente.

PARA MÁS INFORMACIÓN:

www.sacipumps.com
saci@sacipumps.com

BOMBAS SACI S.A. no se hace responsable de las posibles inexactitudes contenidas en el presente documento, debidas a errores de impresión o de transcripción, y se reserva el derecho de aportar a sus productos las modificaciones que considere necesarias y que no perjudiquen las características esenciales de dichos productos.

GENERAL SALES CONDITIONS

ORDERS

Orders will preferably be placed by email, mentioning the order number, the product reference, and the shipping address, and will be registered the actual price list.

For orders of material manufactured on demand (non-standard material), the corresponding offer sealed and signed by the buyer will be required.

SACI PUMPS reserves the right to supply products to those customers who at the time of delivery have unpaid balances with our Company. As long as the client has not satisfied the total value of the merchandise, SACI PUMPS reserves the domain of the same.

DELIVERY TIME

The delivery times provided by our commercial department are indicative, and the informed date is always understood as the date in which the goods are ready to be collected, so claims for delays in delivery time will not be addressed.

DELIVERY TERMS

International shipments are always ExWorks.

SACI PUMPS can take care of the documentation and shipment of the products prior agreement with our export department. In this case, the shipping costs, documents and official legalizations necessary for the export of the material will always be borne by the buyer and will be charged on the invoice.

RETURNS

Material returns will not be accepted after 15 days from receipt.

In case of return within this period, the material must be sent to us perfectly packed and postage paid, or picked up by our transport agency prior agreement with our export department. Any return postage due will be refused. Once the material is received, its condition will be reviewed and the necessary concepts will be charged to return the material and its packaging in perfect condition.

Data referring to its issuance and invoicing (invoice number) must be indicated in the documentation.

Specially manufactured products are not subject to return except for a manufacturing defect, or unless previously agreed with our export department, and in this case, a demerit will be applied depending on the cause.

WARRANTY

SACI PUMPS guarantees all its products against any manufacturing defect for a period of 2 years from the invoice date of the product.

Only damaged parts and not the complete set will be accepted under warranty. The warranty is limited to the replacement of defective parts and labour to replace them in our authorized workshops, and in any case we will accept charges for labour, compensation, travel or assembly and disassembly labour of the pumps at the customer's premises.

FOR MORE INFORMATION:

www.sacipumps.com
saci@sacipumps.com

SACI PUMPS is not responsible for possible inaccuracies contained in this document, due to printing or transcription errors, and reserves the right to make any modifications to its products that it deems necessary and that do not harm the essential characteristics of said products.

Innovadores por excelencia
La calidad de producto es nuestro compromiso
Su satisfacción es nuestra motivación
Comprometidos con el medio ambiente

*Innovators par excellence
Product quality is our commitment
Your satisfaction is our motivation
Committed to the environment*



saci
pumps



BARCELONA

C./ Can Muntanyola, 4-22
Pol. Ind. Palou Nord
08401 Granollers, Barcelona- Spain
Tel. +34 93 384 23 51
saci@sacipumps.com

A CORUÑA

Poligono Pocomaco, Parcela D-31
15190 A Coruña- Spain
Tel. +34 981 29 96 88
sacicoruna@sacipumps.com

LEVANTE

C/ Mónaco, Nave 39
Pol. Ind. Ciudad del Transporte II
12006 Castellón de la Plana- Spain
Tel. +34 964 33 44 66
sacilevante@sacipumps.com

www.sacipumps.com

